



NEW!
EXTENDED
PRODUCT RANGE

More than lifting

Demag DH. The hoist unit.

DEMAG

Demag DH. The hoist unit: Beyond classic crane applications



42887



25688



41917-21

DH hoist unit with two rope lead-offs for transporting mould jigs without any hook travel

DH hoist units in automotive production for e-mobility

Demag DH hoist units can be used in a wide variety of applications, both as travelling hoists on cranes or monorails and as stationary solutions. These powerful hoist units offer a number of special technical features that enable loads to be handled reliably even under demanding requirements. More than lifting: Installed as stationary or travelling units, they are more than just hoists – thanks to gentle handling with high load capacities up to 100 tons and flexible integration into almost any design.

BUILT TOUGH

DH hoists are robust to ensure reliable operation even in the toughest environments. Demag hoist units are designed for demanding applications such as foundries or electroplating plants with high ambient temperatures, high dust levels and aggressive environments. They can also withstand the adverse conditions typically encountered by rope hoists.

VERSATILE

Their modular concept and flexible mounting arrangements enable DH hoist units to be integrated into almost any structure with ease. Their many variants and options facilitate an almost unlimited range of applications. For example, you can find these hoists in lifting stations, winch arrangements and architectural applications – sometimes it takes a closer look to even discover them.

NEW!
STANDARDISED OPTION
WITH FREQUENCY INVERTERS

DH: YOUR BENEFITS

- Rugged design – proven worldwide
- Easy integration into any design
- High switching frequencies and high duty cycles
- Precise positioning with mechanical microspeed or frequency-controlled lifting
- Load capacity up to 100 t
- Hook path up to 104 m



38318-4

Lifting and lowering a steel and glass roof structure with 4 DH hoist units

TECHNICAL FEATURES

- High number of starts/stops and high duty factor thanks to mechanical microspeed and conical-rotor brake motors, also for high ambient temperatures
- Highly precise positioning with 1:10 mechanical microspeed
- NEW: Frequency-controlled lifting as standardised option
- Rope drums available with multi-groove designs
- Safe and reliable monitoring of the limit positions by geared limit switch
- Simple integration into almost any design
- Torsionally rigid frame, for bolted connection on all sides
- Rope lead-off possible in any direction
- Rope reeving according to customer requirements
- Wide range of lifting speeds
- Optionally with or without electric equipment
- Wide range of industry solutions available



40670-59

Dam beams are positioned with 2 DH hoist units at water depths of up to 22 m.



39304-38

4 synchronised DH hoists for precise transport of aircraft fuselage segments

DH hoists hold and position the central video cube in a football stadium.



40849-6

Demag DH. The hoist unit.

Universal. Safe. Rugged.

Demag DH hoist units are based on perfectly matched and robustly designed components. This means that they offer optimum conditions for individual solutions, even for unusual applications. Demag DH hoist units are in operation all over the world and offer outstanding safety and reliability.



GEARBOX ASSEMBLY

- Space-saving planetary gearbox arrangement, integrated and protected inside the drum
- High safety and reliability and long service life thanks to load and output distribution
- High efficiency, low noise, lubricated for life



OPTIONAL ELECTRIC CONTROL EQUIPMENT

- Monitoring with evaluation unit, CAN bus compatible, smart linking of:
- DGS 4 geared limit switch for reliable cut-off of the hoist unit
- Electronic load monitoring and evaluation
- Smart features such as slack rope cut-off and load display



BOTTOM BLOCKS WITH DIN-RATED LOAD HOOKS

- Single or multi-sheave bottom blocks depending on rope reeving
- Safe handling thanks to DH-specific rope sheave cover
- Custom applications, including 8/4-4; 4/2-2



ROPE GUIDE

- Slack rope protection by closed rope guide
- Made of acid-resistant PA12
- Inclined pull of up to 4° without touching the rope guide
- Reinforced versions also available

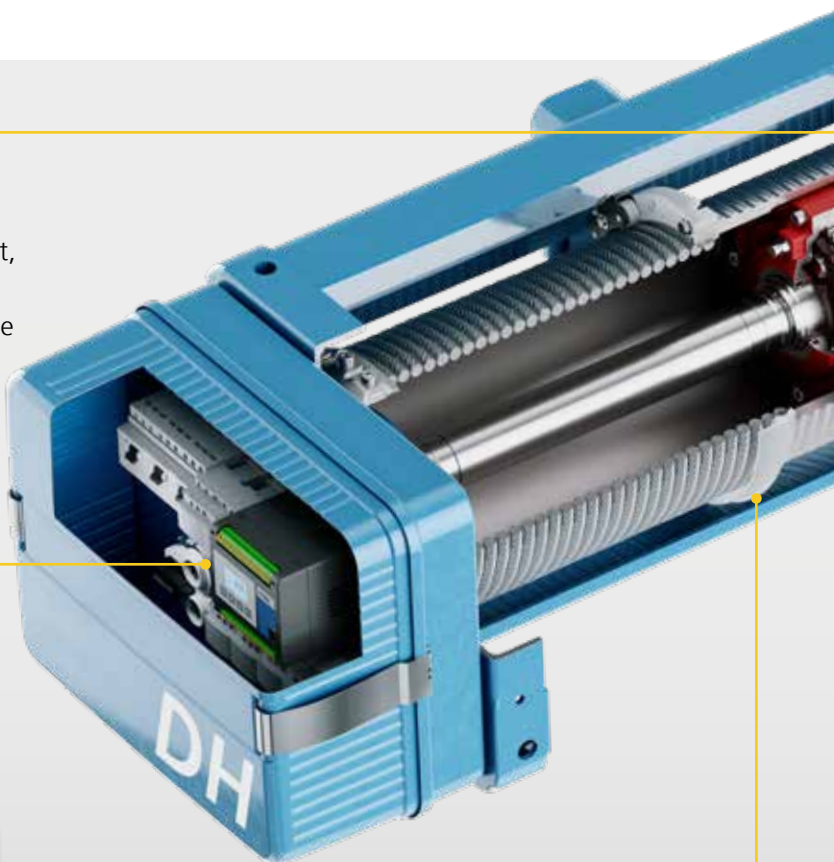



42935-2

ROPE DRUM BRAKE (OPTIONAL)

- Safety brake (also as a holding brake), acting directly on the rope drum

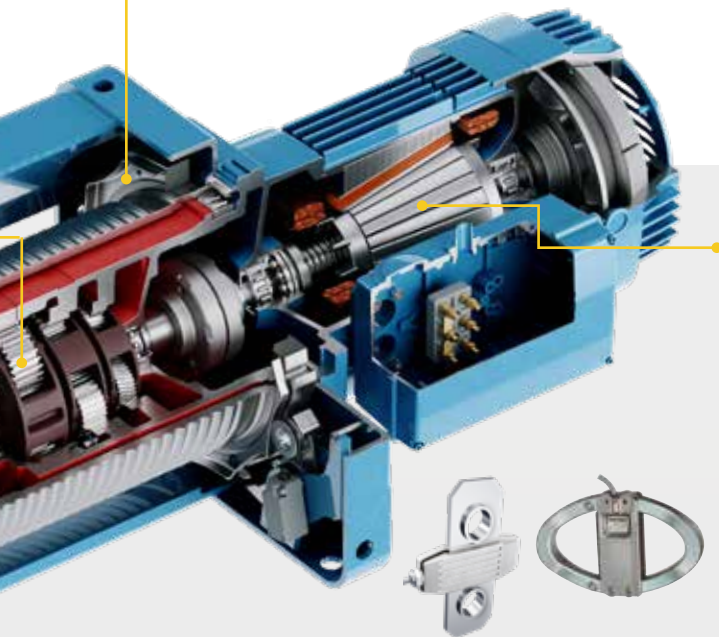

LOAD DETECTION

- Limit switch with mechanically actuated microswitches and evaluation electronics for overload protection and cut-off or
- strain gauge carrier link with precise strain gauge technology, frequency generator and evaluator for overload protection and cut-off.
- This solution provides setpoint load limitation, summation measurement and cut-off in the event of slack rope.
- In addition: load display possible via display screen



42941



42942

DRIVE WITH INFINITELY VARIABLE LIFTING SPEEDS

- Infinitely variable lifting speeds with inverter-controlled brake motor
- Proven Demag drive technology with Demag ZBA cylindrical-rotor motors
- With external pulse generators for speed feedback to the frequency inverter
- Motor brake with adjustment monitoring and brake release monitoring
- Motor temperature monitoring as standard

DRIVE WITH MAIN LIFTING AND CREEP LIFTING SPEEDS

- High braking capacity and reliable braking without any control devices when switching off or in the event of a power failure

Main and creep lifting speeds with F6 pole-changing (1:6 speed ratio)

- Sliding-rotor motors with integrated conical brake
- Motor temperature monitoring as standard
- Main and creep lifting speeds with F6 pole-changing
- Demag drive technology with Demag KBH squirrel-cage motors
- Reliable and efficient

DEMAG CONTROL ELEMENTS (ACCESSORIES)

DRC RADIO CONTROL

- Highly reliable data transmission via frequency hopping
- 100 m range

DEMAG DST PENDANT CONTROLLER

- Rugged housing (GRP)
- Contactor control
- High switching capacity
- Acid-resistant control elements (option)

Main and creep lifting speeds with F10 mechanical micro- speed unit (1:10 speed ratio)

- Demag drive technology with Demag KBH and KBA squirrel-cage motors
- Separate motors for main and creep lifting motions
- Particularly precise positioning



DST-3

DST-7

DST-9

40793-1

40791-4

40790-1

Models

Stationary or mobile? Everything is possible.

TROLLEYS

- Travel wheels made of high-strength spheroidal-graphite cast-iron
- Particularly gentle on the track, quiet running thanks to effective vibration damping
- Lower friction and high wear resistance due to self-lubrication effect of embedded nodular graphite
- Optimum load distribution thanks to special travel wheel shape, which transmits wheel contact forces close to the centre of the girder
- Generously dimensioned anti-friction bearings with long service life

DEMAG ZBF AND ZBA TRAVEL MOTORS

- Smooth starting and gentle braking
- Low-sway load motion
- Fast and precise approach to the desired position
- Proven Demag drive technology **Made in Germany.**



DH hoist in a foundry for safely handling molten masses Full-portal crane with DH hoist units in tandem mode



Direct connection of Demag F-DH hoist units
Square frame design can be mounted on any side.
Load capacity: up to 100 t.



EK-DH low-headroom monorail hoist
Trolley with favourable C-dimension.
Also available as an articulated trolley.
Load capacity: up to 16 t



Stationary DH rope hoists used for moving a domed retractable roof



42892

EU-DH standard-headroom monorail hoist

Cost-effective solution for monorails with infinitely variable flange width adjustment. Also as EUD-DH articulated trolley. Load capacity: up to 16 t (optionally also up to 50 t).



42895

EZ-DH double-rail crab

For higher load capacities on double-girder cranes; optimum use of space thanks to low-headroom design and favourable approach dimensions. Load capacity: up to 100 t.

Drive concept: Customised motions

Precise. Rugged. High performance. For our DH hoist range, we offer three different drive concepts that have proven themselves in a wide range of applications. Based on reliable series components, lifting solutions can be specifically configured for any requirement. With the "Made in Germany" seal of quality.



DRIVE WITH MAIN LIFTING AND CREEP LIFTING SPEEDS

Our conical-rotor brake motors with outputs of up to 40 kW are used as starting/stopping drives. The pole-changing motors have two speeds and work reliably even with extremely high switching frequencies. The mechanical connection between the conical brake and rotor creates a unique braking principle with high braking capacity. This makes these motors superior wherever the highest demands are placed on the brake. Separate control and additional switching elements are not required. The sliding-rotor motors are equipped with motor temperature monitoring as standard.

MAIN AND CREEP LIFTING SPEEDS WITH F6 POLE-CHANGING

- Proven Demag drive technology with Demag KBH squirrel-cage motors
- Reliable and efficient in starting/stopping applications – also with high duty factor

MAIN AND CREEP LIFTING SPEEDS WITH F10 MECHANICAL MICROSPEED UNIT

- Demag KBH and KBA squirrel-cage motors
- Separate motors for main and creep lifting motions
- Particularly precise positioning
- High braking capacity and reliable braking without any control devices when switching off or in the event of a power failure

DRIVE FOR INFINITELY VARIABLE LIFTING SPEEDS

The combination of our ZBA cylindrical-rotor brake motors with Dedrive Compact frequency inverters creates powerful lifting units with infinitely variable speeds. And they offer impressive performance:

- High drive efficiency with motor outputs of up to 40 kW
- Infinitely variable lifting speeds with inverter-controlled brake motor

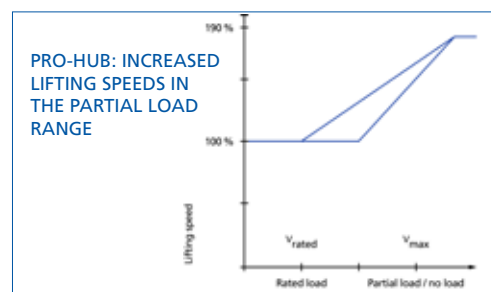

- With external pulse generators for speed feedback to the frequency inverter
- Motor brake with adjustment monitoring and brake release monitoring
- Motor temperature monitoring as standard
- Also ready for customer drives and control solutions

Demag rope guides

Protection against extreme loads, precisely guided

Rope guides protect Demag DH hoist units against extreme loads caused by inclined pull, load sway and rope vibrations.

Made of tough, wear-resistant plastic, our rope guides can accommodate inclined pull of up to 4° without any contact. Two-part units, easily replaceable without special tools. Reinforced rope guides are available for special loads.



STANDARD PA 12 ROPE GUIDE

Wear-resistant made of acid-resistant PA12 plastic. Slack rope protection thanks to enclosed design and pressure roller.

ROPE GUIDE TYPE F

Frost-resistant and reinforced. Suitable for outdoor use.

ROPE GUIDE TYPE S

Heavy, double reinforced for medium inclined tensile loads, also at low temperatures.

DOUBLE ROPE GUIDE TYPE DSZ

For heavy-duty hoist units with double-groove drum, especially in heavy-duty operating conditions with magnet or grab operation. Reduced sway.

Always there for you

Our **Demag partners** are available to you worldwide with a wide range of services. You can extend the useful life of your Demag equipment with our innovative service products, modernisations or warranties, as well as proven maintenance and inspection services. Your local partner will be happy to advise you.

The **Demag Repair Centre** at our production plant in Wetter (Germany) can advise you on repairs, modernisations or general overhauls.

DEMAG REPAIR CENTER CONTACT DETAILS

Phone: +49 (0) 2335 92-2414

Email: repaircenter@demagcranes.com



DH hoist unit selection criteria

EXPLANATION OF SIZE DESIGNATIONS

E	U	DH	1050	H16	K	V1 -	4 / 1	F6	-	12.5
										Cross-travel in m/min
										F1 - frequency controlled F 6 - creep lifting 1:6 DH (pole-changing) F 10 - creep lifting 1:10 DH (mechanical creep lifting)
										Single-groove drum 4-fall reeving
										Lifting speed
										Motor type: K = squirrel-cage rotor/Z = cylindrical rotor
										Hook path 16 m (for 2/1 reeving)
										1000 series Size 1050 Rope force on the drum: 50 kN
										Demag hoist unit – DH model
										F = foot-mounted hoist U = standard-headroom monorail hoist K = low-headroom travelling hoist Z = double-rail crab
										E = electric trolley

ROPE REEVING ARRANGEMENTS

The right variant for every application

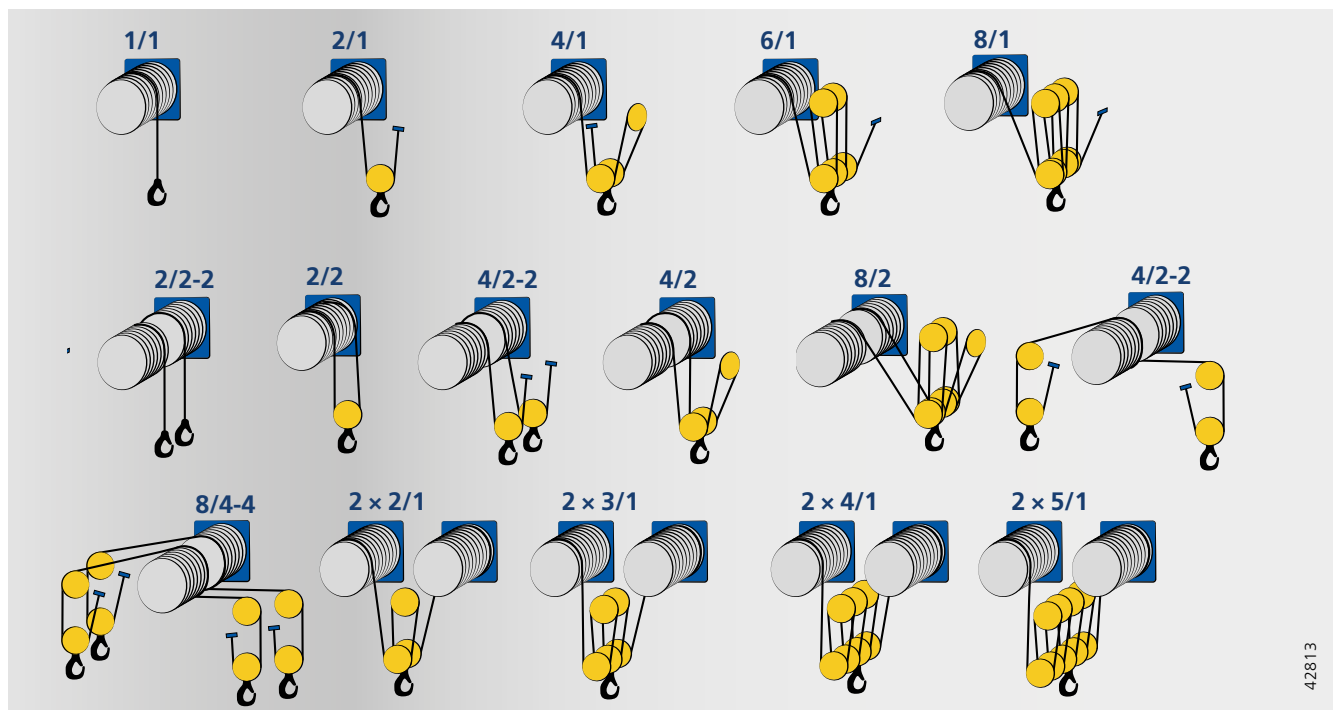

THE OPERATING TIME AND LOAD SPECTRUM ARE USED TO DETERMINE THE GROUP.

EXAMPLE

Load capacity	10,000 kg
Load spectrum	"Light" from table
Lifting speed	8 m/min
Creep lifting speed	1.3 m/min
Reeving	2/1
Average hook path	4 m
Number of cycles/hour	20
Working time/day	8 hour

Example for calculation to FEM/ISO

The average operating time per working day is estimated or calculated as follows:

$$\text{Operating time/day} = \frac{2 \times \text{average hook path} \times \text{no. of cycles/h} \times \text{working hours/day}}{60 \times \text{lifting speed}}$$

$$= \frac{2 \times 4 \times 20 \times 8}{60 \times 6} = 2.66 \text{ hours}$$

Load spectrum		Average operating time per working day [h]				
1	Light	up to 2	2-4	4-8	8-16	over 16
2	Medium	up to 1	1-2	2-4	4-8	8-16
3	Heavy	up to 0.5	0.5-1	1-2	2-4	4-8
4	Very heavy	up to 0.25	0.25-0.5	0.5-1	1-2	2-4
Group of mechanisms to FEM		1Bm	1 Am	2 m	3 m	4 m
Group of mechanisms to ISO		M3	M4	M5	M6	M7
Reeving arrangement						
2/2-2	4/2	8/2				
1/1	2/1	4/1	6/1	8/1		
Load capacity [kg]		Range		Size		
1,000	2,000	4,000			410	
1,250	2,500	5,000	-	-	DH	412
1,600	3,200	6,300	-	-	DH	416
2,000	4,000	8,000	12,500	16,000	DH	420
2,500	5,000	10,000	16,000	20,000	DH	425
3,200	6,300	12,500	20,000	25,000	DH	632
4,000	8,000	16,000	25,000	32,000	DH	640
5,000	10,000	20,000	32,000	40,000	DH	1050
6,300	12,500	25,000	40,000	50,000	DH	1063
8,000	16,000	32,000	50,000	63,000	DH	2080
10,000	20,000	40,000	63,000	80,000	DH	2100
12,500	25,000	50,000	80,000	100,000	DH	2125

NEW!
NOW ALSO WITH DH 400

LOAD SPECTRUM

(estimated in most cases) can be determined using the following diagram:

1 LIGHT

Hoist units which are usually subject to very low loads and only in exceptional cases to maximum loads.

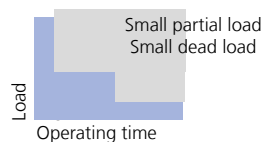

2 MEDIUM

Hoist units which are usually subject to low loads but often to maximum loads.

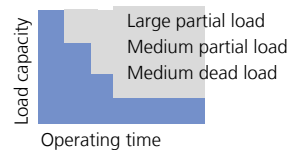

3 HEAVY

Hoist units which are usually subject to medium loads but frequently to maximum loads,

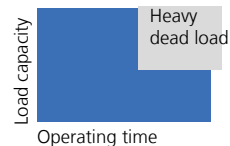

4 VERY HEAVY

Hoist units which are usually subject to maximum or almost maximum loads.



Closed-circuit track with DH hoist units operating under demanding conditions in an electroplating plant

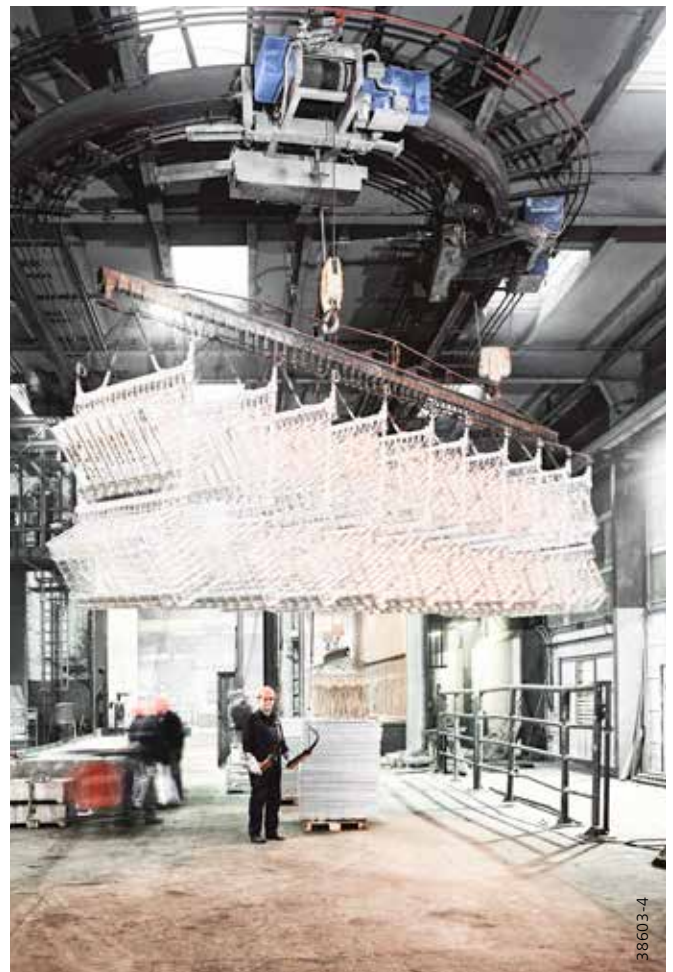

38603-4

DH HOIST UNIT SELECTION CRITERIA

DH range	Group of mechanisms	1/1; 2/2-2 reeving				2/1; 4/2 reeving				4/1; 8/2 reeving			
		Load capacity	Max. lifting speed ¹⁾	Hook path		Load capacity	Max. lifting speed ¹⁾	Hook path		Load capacity	Max. lifting speed ¹⁾	Hook path for reeving	
		[kg]	[m/min]	[m]		[kg]	[m/min]	[m]	[m]	[kg]	[m/min]	[m]	[m]
				1/1	2/2-2			2/1	4/2			4/1	-
DH 410	4m	1,000	32			2,000	16			4,000	8		
DH 412	3m	1,250	25			2,500	12.5			5,000	6.3		
DH 416	2m	1,600	25	24; 40	12.6; 24	3,200	12.5	12; 20	6.3; 12	6,300	6.3	6; 10	
DH 420	1Am	2,000	20			4,000	10			8,000	5		
DH 425	1Bm	2,500	16			5,000	8			10,000	4		
				1/1	2/2-2			2/1	4/2			4/1	-
DH 616	4m	1,600	32			3,200	16			6,300	8		
DH 620	3m	2,000	25			4,000	12.5			8,000	6.3		
DH 625	2m	2,500	25	24; 40; 80; 104	10.4; 20.4; 45.2; 60.4	5,000	12.5	12; 20; 40; 52	5.2; 10.2; 22.6; 30.2	10,000	6.3	6; 10; 20; 26	
DH 632	1Am	3,200	20			6,300	10			12,500	5		
DH 640	1Bm	4,000	16			8,000	8			16,000	4		
				1/1	2/2-2			2/1	4/2			4/1	8/2
DH 1025	4m	2,500	50			5,000	25			10,000	12.5		
DH 1032	3m	3,200	36	32; 48; 80;	16; 27; 49.6;	6,300	18	16; 24; 40; 51	8; 13.5; 24.8; 33	12,500	9	8; 12; 20; 25.5	8; 12; 20; 25.5
DH 1040	2m	4,000	36			8,000	18			16,000	9		
DH 1050	1Am	5,000	32	102	66	10,000	16			20,000	8		
DH 1063	1Bm	6,300	22.4			12,500	11.2			25,000	5.6		
				1/1	2/2-2			2/1	4/2			4/1	8/2
DH 2050	4m	5,000	32			10,000	16			20,000	8		
DH 2063	3m	6,300	25	36; 54; 94	13.8; 24.8 48.8	12,500	12.5	18; 27; 47	6.9; 12.4; 24.4	25,000	6.3	9; 13.5; 23.5	6.1; 12.1
DH 2080	2m	8,000	25			16,000	12.5			32,000	6.3		
DH 2100	1Am	10,000	20			20,000	10			40,000	5		
DH 2125	1Bm	12,500	16			25,000	8			50,000	4		
DH range	Group of mechanisms	6/1 reeving			8/1 reeving								
		Load capacity	Max. lifting speed ¹⁾	Hook path	Load capacity	Max. lifting speed ¹⁾	Hook path						
		[kg]	[m/min]	[m]	[kg]	[m/min]	[m]						
				6/1			8/1						
DH 1040	2m	25,000	6	8;	32,000	4.5							
DH 1050	1Am	32,000	5.3	13.3;	40,000	4	6; 10; 12.7						
DH 1063	1Bm	40,000	3.7	17	50,000	2.8							
				6/1			8/1						
DH 2080	2m	50,000	4.2	6;	63,000	3.1							
DH 2100	1Am	63,000	3.3	9;	80,000	2.5	6.8; 11.8						
DH 2125	1Bm	80,000	2.7	15.7	100,000	2							

1) Available creep lifting mode: Main and creep-lifting speeds F6 (1:6 speed ratio) with a 2/12 pole-changing motor, F10 (1:10 speed ratio) with mechanical microspeed unit and FI with a frequency inverter-fed motor in the technical product documentation and on request.

DEMAG CRANES & COMPONENTS GMBH

Wetter site
 Ruhrstrasse 28
 58300 Wetter, Germany
E info@demagcranes.com
T +49 2335 92-0
F +49 2335 92-7676
 www.demagcranes.com

